

FASTENERS - TOOLS - STRUCTURE
FOR DECKING

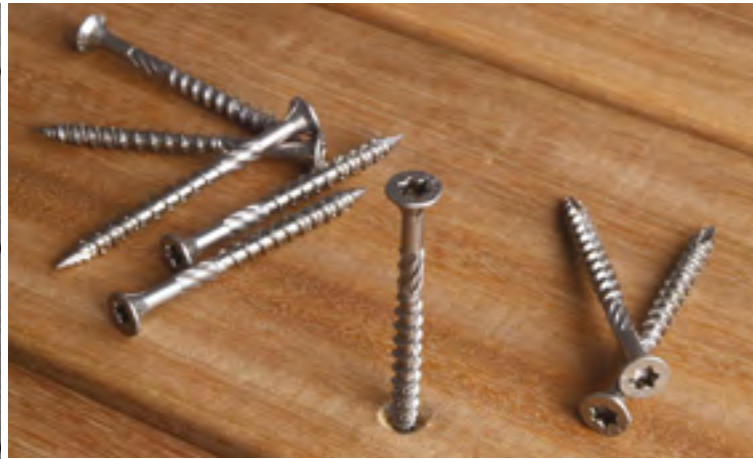



FASTENING AND STRUCTURAL SYSTEMS FOR WOOD & COMPOSITE DECKS

A successful decking project requires that you follow a few simple rules of installation and more particularly that you take into account good ventilation of the structure and avoid water traps. Wood is a living material that shrinks and expands depending on the humidity of the ambient air. It is therefore important to follow local recommendations.

Simplicity and reliability

Specialists in wood decking for more than 15 years, we have been actively involved in the development of accessories to create quality decks.

Our teams have developed many products that facilitate the installation of wooden decks such as Cobra stainless steel clips, screwing templates or board straighteners. Other products increase the lifetime of under-structure such as pads, joist protection tape or ground screws.

Our latest Cobra Hybrid clip (bi-material stainless steel clip) allows the installation of all types of composite boards with a 30% time saving on installation without pre-drilling. The pre-loaded screw on the clip is compatible with all joists (softwood, exotic or aluminum).

For a terrace that lasts a long time

Our goal is to make the construction of wood decks more reliable by proposing innovative concepts such as the "Structural" aluminum structure. A rot-proof and solid structure that increases the life of the decks, but also improves their stability.

Cobrafastener

Smart" products to succeed in your projects in complete safety. Reliable and proven products, flexible logistics and a stock always available to be your partner for decking accessories.

FASTENERS

- Cobra® HYBRID clips 8-18 page 04
- Cobra® clips (20/24) page 05
- Cobra® finishing clips (20/24) page 06
- Cobra® Universal Clips D-LOCK page 07
- Ventilation Pad AIRSPACER..... page 08
- Cobra® screws for wood decks / wood joists page 09
- Cobra screws for Composite wood deck / wood joists page 10
- Cobra® screws for wood decks / Aluminum joists page 11

TOOLS

- Cobra® SMART BIT drill and countersink tool and step drill tool pages 12 - 13
- Cobra® DECK SPACER page 14
- Cobra® LINER installation template page 15
- Cobra® WRENCH board straightener page 16

STRUCTURE

- Pedestals NIVO pages 17 - 19
- STRUCTURAL pages 20 - 21
- Aluminium Joists page 22
- The ground screw, screwing tool and adapter pages 23 - 24
- The joist tape BITUDECK page 25
- The geotextile GEODECK page 26
- Decking PADS pages 27 - 28
- Cobra® SEAL page 29



FASTENERS

Cobra HYBRID 8-18 clips



Features

- Integrated screw, quick installation
- Wood and aluminum joist compatible screws
- Removable clip
- Bi-material clip: Nylon shell and AISI304 stainless steel reinforcement (90 pcs)
- Screw 4.2x35 mm in stainless steel AISI410 (90 pcs)
- Resistant to UV and extreme temperatures
- Color matte black for no light reflection
- Pulling strength up to 300 kg on exotic joists

Logistics

Code FR	Code NL	EAN Code	Qty/package	Qty/pallet	Weight (kg)
0993	2174	3700421809936	20	600	1,00



Dimensions (mm)

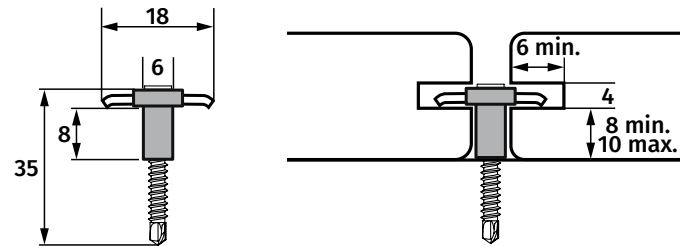

Decking

Exotic woods	Thermo-modified wood	Composite wood
-	✓	✓

Structure

Exotic woods*	Softwood	Aluminium**	Steel
✓	✓	✓	-

* Stable and dried species KD
 ** Maximum thickness: 2 mm

FASTENERS

Cobra 20/24 clips



Features

- Removable clip
- Stainless steel clip AISI304 (90 pcs)
- Screw 4.5x25mm in stainless steel AISI410 (90pcs)
- Resistant to UV and extreme temperatures
- Color matte black for no light reflection
- Pulling strength up to 250 kg on exotic joists

Logistics

Designation	Code FR	Code NL	EAN Code	Qty/package	Qty/pallet	Weight (kg)
Cobra 20	0043	1049	3760178990332	20	600	0,90
Cobra 24	0014	1047	3700421800148	20	600	1,00



Dimensions (mm)

Designation	A	B	C	D	X	Y	Z
Cobra 20	25	22	8	6	8	4 min	10 min
Cobra 24	25	22	10	6	10	4 min	10 min

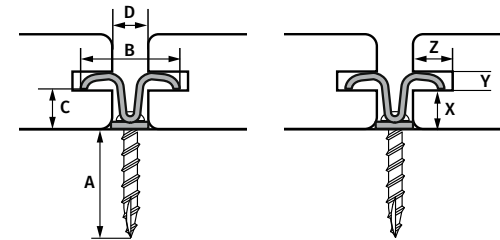

Decking

Exotic woods	Thermo-modified wood	Composite wood
-	✓	✓

Structure

Exotic woods*	Softwood	Aluminium	Steel
✓	✓	-	-

* Stable and dried species KD, pre-drilling recommended

Cobra 20-24 finishing clips



Features

- Aesthetic finish of a deck installed with Cobra clips
- Stainless steel clip AISI304 (30pcs)
- Screw 4.5x25mm in stainless steel AISI304 (30pcs)
- Resistant to UV and extreme temperatures
- Color matte black for no light reflection

Logistics

Designation	Code FR	Code NL	EAN Code	Qty/package	Qty/pallet	Weight (kg)
Cobra 20 Start/End	0336	1773	3700421803361	16	960	0,65
Cobra 24 Start/End	0335	1774	3700421803354	16	960	0,60



Dimensions (mm)

Designation	X	Y	Z
Cobra 20 Start/End	8	4 min	10 min
Cobra 24 Start/End	10	4 min	10 min

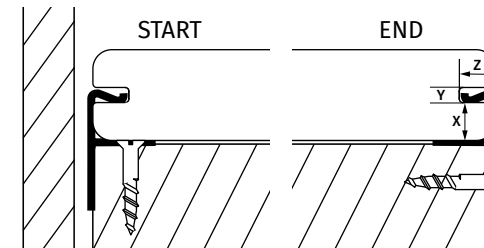

Decking

Exotic woods	Thermo-modified wood	Composite wood
-	✓	✓

Structure

Exotic woods*	Softwood	Aluminium	Steel
✓	✓	-	-

*Pre-drilling required

D-LOCK universal clips



Intermediate clip

Start/End Clip

Features

- Universal clip for deck boards from 20 to 28 mm thick and 90 to 150 mm wide.
- Fastening system adapted to non grooved decking boards
- Provides ventilation under the board
- Strong and resistant to humidity and extreme temperatures
- Made of polymer material of the POM type: polyoxymethylene
- Compatible with all wood decking and structure, with compulsory pre-drilling.

Logistics

Code FR	Code NL	EAN Code	Qty/package	Qty/pallet	Weight (kg)
0600		3700421806003	8	144	2,20



Dimensions (mm)

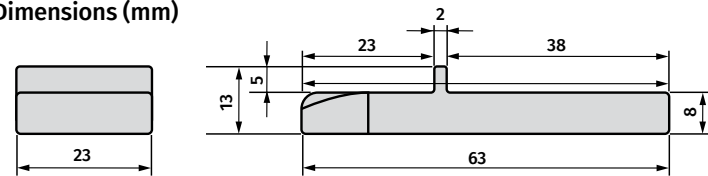

Contents

- 110 Fixing clips dimension: 23x60x8mm
- 15 Start/End Clips
- 250 stainless steel screws: 4 x 25 mm
- 55 stainless steel screws: 4 x 40 mm
- 1 Metal drilling template
- 4 board spacers: DECKSPACER®.

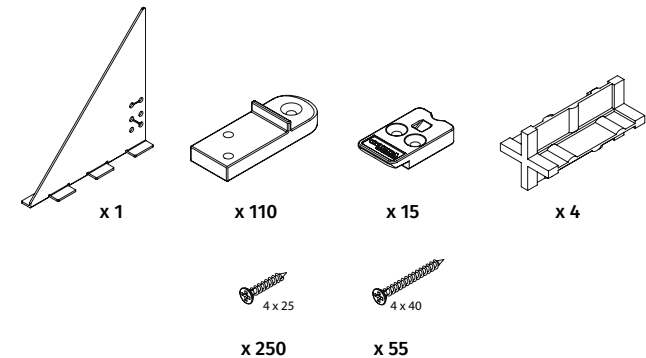



Features

- 4 board spacers 3 / 4 / 5 / 6 mm included.
- Provides ventilation between the boards and joists.
- Increases the lifetime of the deck.
- Recycled polyamide, UV, heat and frost resistant.
- Complies with the decking standards requirements

Logistics

Code FR	Code NL	EAN Code	Qty/package	Qty/pallet	Weight (kg)
1040		3700421810406	8	192	0,75



Dimensions (mm)

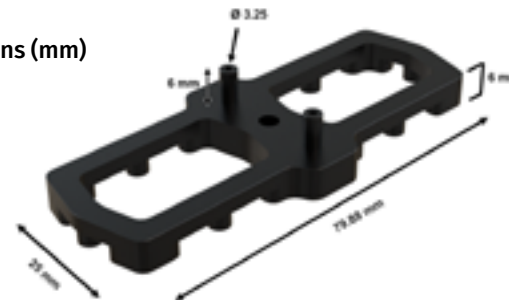

Contents

- 100 AIRSPACER®
- 4 boards spacers: DECKSPACER®

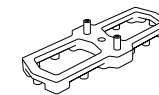

x 100

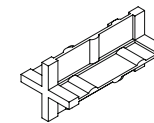

x 4

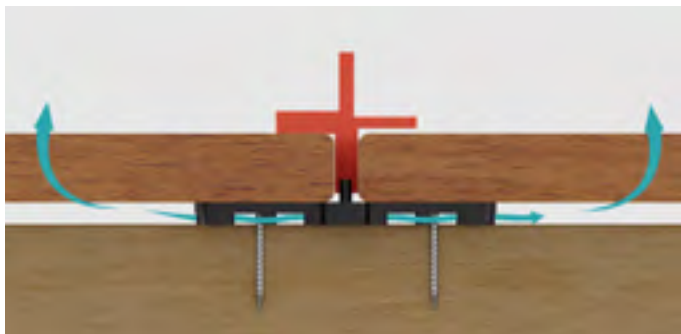

FASTENERS

Wood deck screws / wood joists



Features

- Stainless steel screws AISI304
- Sharp thread for better penetration in wood
- Sharp point to reduce wood splitting
- Spiral top to facilitate the penetration of the screw in the wood
- Deep Torx recess to prevent bit rejection and slippage

Logistics

Designation	Code FR	Code NL	EAN Code	Qty/package	Qty/pallet	Weight (kg)
5x50 mm (200 pcs)	0601		3760180240470	12	288	0,90
5x50 mm (500 pcs) + 4 spacers + 1 drill bit	0799		3760180247448	6	144	2,25
5x60 mm (500 pcs) + 4 spacers + 1 drill bit	0966		3700421809660	6	144	2,80
5x60 mm (200 pcs)	0602		3760180240852	6	288	0,98
6x70 mm (100 pcs)	0613		3700421806133	6	288	0,95

Dimensions (mm)

Designation	Size	A (mm)	L (mm)	U (mm)	D (mm)	dr (mm)	Torx
0601 - 0799	M5x50	8	50	4	5	4	T25
0602 - 0966	M5x60	8	60	8	5	4	T25
0613	M6x70	10	70	10	6	5	T30

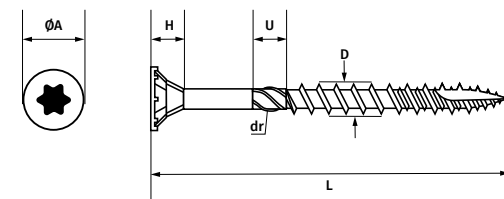

Decking*

Designation	Board thickness (mm)**	Density of the wood (kg/m³)	
		<600	>=600
0601 - 0799	21-23	Vis M5x50	Vis M5x60
0602 - 0966	24-27	Vis M5x60	Vis M6x70
0613	28	Vis M6x70	Vis M6x70

Structure

Exotic woods**	Softwood	Aluminium	Steel
✓	✓	-	-

* According to decking standards requirements
 ** Pre-drilling is strongly recommended in hardwoods

FASTENERS

Composite wood deck screws / wood joists



Features

- Stainless steel screws AISI304
- Sharp thread for better penetration in composite wood
- Reduced head
- Double thread to avoid mushrooming effect
- Identical colors to the boards for a nice finish
- Compatible with all brands of solid core composite wood

Logistics

Designation	Code FR	Code NL	EAN Code	Qty/package	Qty/pallet	Weight (kg)
5x50 mm Grey (150 pcs)	0770	2026	3700421807703	30	900	0,85
5x50 mm Brown (150 pcs)	0771	2027	3700421807710	30	900	0,85
5x63 mm Grey (100 pcs)	0729		3700421807291	30	900	0,55
5x63 mm Brown (100 pcs)	0728		3700421807284	30	900	0,55



Dimensions (mm)

Designation	Size	A (mm)	L (mm)	D1 (mm)	D2 (mm)	D3 (mm)	Torx
0770 - 0771	M5 x 50	7,5 - 8	50	5.2-4.9	4.0-4.3	4,9-5.2	T20
0728 - 0729	M5 x 63		63				

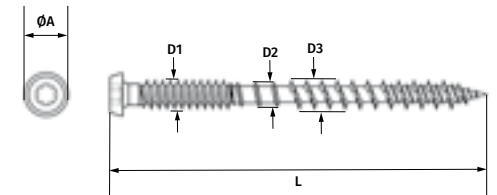

Decking

Designation	Boardthickness (mm)	Screw size
0770 - 0771	20-22	M5 x 50
0728 - 0729	24	M5 x 63

Structure

Exotic woods*	Softwood	Aluminium	Steel
✓	✓	-	-

* Pre-drilling required

FASTENERS

Wood deck screws / Aluminum joists



Features

- AISI316 stainless steel screws: Compatible with areas highly exposed to saline environments.
- Narrow, stepped screw head to reduce wood splintering.
- Small Head perfectly embedded, optimal pressing
- Wing for self-drilling of the wood board, and brittle in aluminium
- Self-drilling point. Aluminium wall drilling up to 3 mm.



Logistics

Designation	Code FR	Code NL	EAN Code	Qty/package	Qty/pallet	Weight (kg)
5.5x40 mm (200pcs)	0955	2395	3700421809554	12	360	1,10
5.5x50 mm (200pcs)	1258		3700421812585	8	240	1,35

Dimensions (mm)

Designation	Size	A (mm)	L (mm)	D (mm)	lt (mm)	Torx
0955	M5.5 x 40	7,9 - 8	40	5.5	9.5	T20
1258	M5.5 x 50		50			

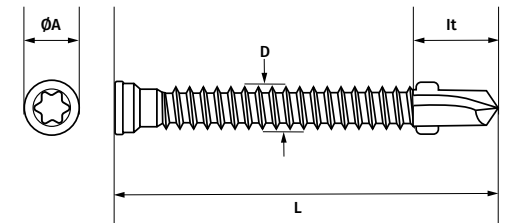

Decking

Designation	Boardthickness (mm)	Screw size
0955	20-22	M5.5 x 40
1258	22-28	M5.5 x 50

Structure

Exotic woods*	Softwood	Aluminium	Steel
-	-	✓	-



TOOLS

Cobra Smart Bit **Drill and countersink**



Features

- 2 in 1 tool: drill and countersink the deck board for a perfect finish.
- Stop on anti-track bearing thanks to a rubber damping ring.
- 3 HSS Powerbolic® steel drill bits, interchangeable
- Chip Cavity
- Compatible with Cobra screws for wood and WPC



Logistics

Designation	Code FR	Code NL	EAN Code	Qty/package	Weight (kg)
Cobra Smart-bit #8 - 4.5	0214	1770	3700421802142	96	0,10
Cobra Smart-bit #10 - 5.0	0215	1771	3700421802159	96	0,10
Cobra Smart-bit #12 - 6.0	0218	1772	3700421802180	72	0,13

Dimensions (mm)

Designation	φA (mm)	φB (mm)	C (mm)	α (°)
#8 - 4.5	3,2	6,6	30	60
#10 - 5.0	3,6	9,2	30	90
#12 - 6.0	4,0	11	40	82

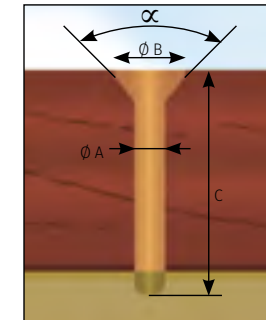
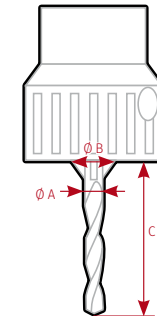

- 1 - Pre-drilling countersink tool
- 2 - Replacement drill bit
- 3 - Hexagonal wrench

Decking

Exotic woods	Thermo-modified wood	Composite wood
✓	✓	✓

Structure

Exotic woods	Softwood	Aluminium	Steel
✓	✓	-	-

TOOLS

Cobra **step drill**



Features

- Wood drill + Chamfering cutter with 5 blades
- Height-adjustable drill bit with allen key
- Compatible with Cobra screws M5x50 mm and M5x60 mm

Logistics

Code FR	Code NL	EAN Code	Qty/package	Weight (kg)
0801	2396	3700421806843	20	0,04



Dimensions (mm)

ØA (mm)	ØB (mm)	C (mm)	α (°)
4,0	11	25-40	90 ± 5

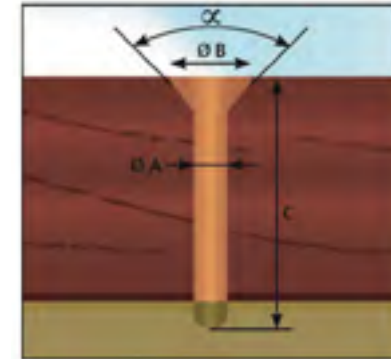

Decking

Exotic woods	Thermo-modified wood	Composite wood
✓	✓	✓

Structure

Exotic woods	Softwood	Aluminium	Steel
✓	✓	-	-

TOOLS

Cobra DECKSPACER

Features

- Ensures regular spacing between boards for expansion and shrinkage of wood, in accordance with the decking standards requirements.
- Guarantees a linear expansion gap at the end of the composite wood boards.
- 4 fins with 4 different spacings

Logistics

Code FR	Code NL	EAN Code	Qty/package	Qty/pallet	Weight (kg)
0604	2338	3700421806041	20	480	0,08



Dimensions (mm)

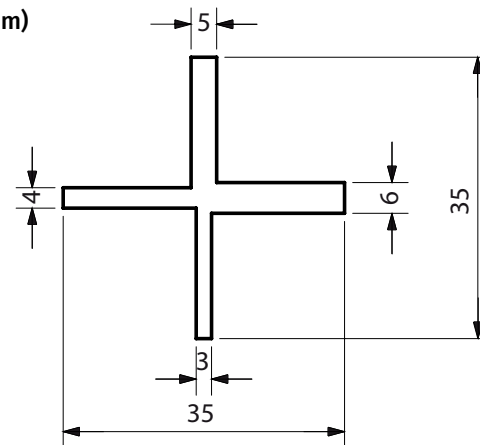

Decking

Exotic woods	Thermo-modified wood	Composite wood
✓	✓	✓



TOOLS

Drilling template Cobra LINER



Features

- Ensures perfect alignment of the screws when screwing in the deck board
- Guarantees 20 mm screw distance from the edge of the boards, in accordance with decking standards
- Adjustable with all boards widths
- Time saving, easy to use
- Supplied with 4 DECK SPACERS included

Logistics

Code FR	Code NL	EAN Code	Qty/package	Qty/pallet	Weight (kg)
0603	2397	3760178992091	20	480	0,63

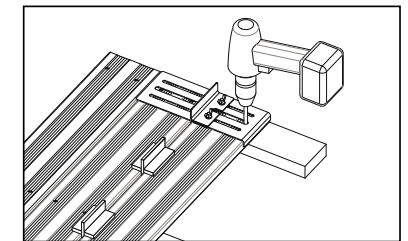
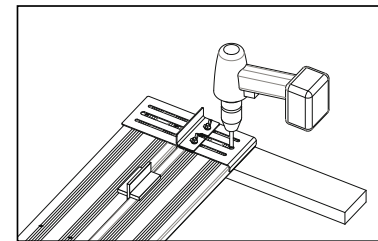
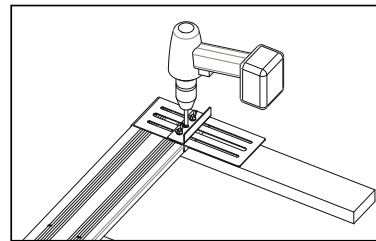

TOOLS

Cobra WRENCH board straightener



Features

- Allows to straighten deformed deck boards with edge deflection
- Easy to use, for a right or left handed user
- Ergonomic and lightweight tool
- Supplied with pins of different sizes, ajustable to the dimensions of the joists

Logistics

Code FR	Code NL	EAN Code	Qty/package	Qty/pallet	Weight (kg)
0216	1056	3760178990349	2	80	1,50

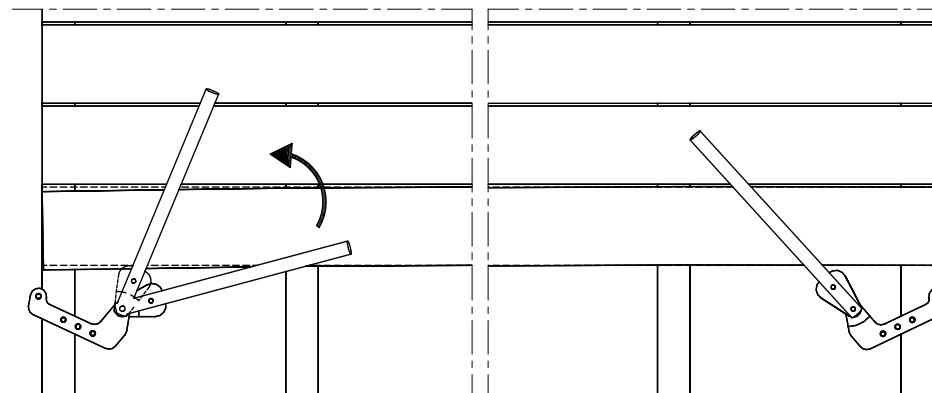



NIVO® JOISTS AND BEAMS

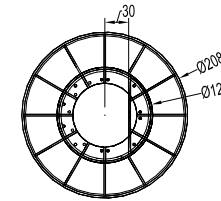
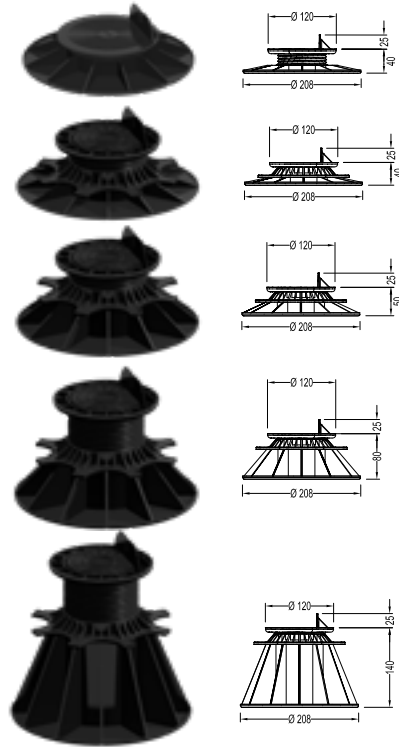

Features

- Top head with joist support
- Height adjustment by micrometric jack
- Supports up to 500 kg (in high position) and up to 1 ton (in the low position), compression load centered on the head of the pedestal
- Complies with decking installation standards
- Resistant to UV, atmospheric agents and temperatures between -30°C and +60°C
- Made from a recycled material and 100% recyclable
- Allows air circulation under the deck, as well as the passage of cables and ducts

Designation	Code FR	Code NL	EAN Code	Qty/package	Qty/pallet	Weight (kg)
H 25 - 40 mm	0113	1038	3760178992039	60	840	0,17
H 40 - 60 mm	0109	1039	3760178990042	60	840	0,23
H 50 - 80 mm	0110	1040	3760178990059	60	600	0,26
H 80 - 140 mm	0111	1041	3760178990066	40	480	0,33
H 140 - 230 mm	0112	1042	3760178990073	40	280	0,51

Designation	Code FR	Code NL	EAN Code	Qty/package	Qty/pallet	Weight (kg)
Extension stud 60 mm	0206	1046	3760178991612	60	1080	0,10
Slope corrector 2-5%	0338	1775	3760178992077	60	1560	0,20



NIVO® pedestals



NIVO® TILES

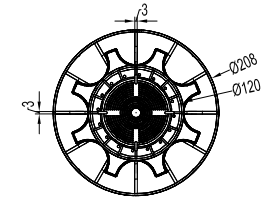
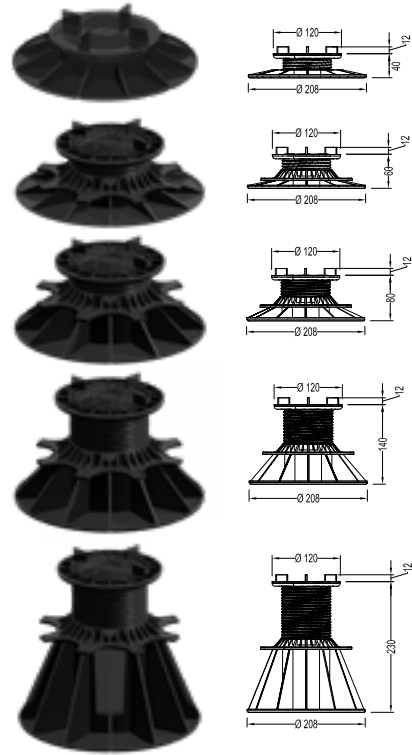

Features

- Top head with tile support
- Height adjustment by micrometric jack
- Supports up to 250 kg (in high position) and up to 1 ton (in low position), compression load on 1/4 of the head of the pedestal
- Complies with decking installation standards
- Resistant to UV, atmospheric agents and temperatures between -30°C and +60°C
- Made from a recycled material and 100% recyclable
- Allows air circulation under the deck, as well as the passage of cables and ducts.
- Compatible with the STRUCTURAL concept

Designation	Code FR	Code NL	EAN Code	Qty/package	Qty/pallet	Weight (kg)
H 25 - 40 mm	0337	2051	3760178992046	60	840	0,17
H 40 - 60 mm	0273	2052	3700421802739	60	840	0,23
H 50 - 80 mm	0274	1043	3760178990127	60	600	0,26
H 80 - 140 mm	0275	1044	3760178990134	60	480	0,33
H 140 - 230 mm	0276	1045	3760178990141	40	280	0,51

Designation	Code FR	Code NL	EAN Code	Qty/package	Qty/pallet	Weight (kg)
Extension stud 60 mm	0206	1046	3760178991612	60	1080	0,10
Slope corrector 2-5%	0338	1775	3760178992077	60	1560	0,20
Shock absorbing pad Thickness 5 mm	0898	2386	3700421808984	42	672	0,03



UNIVERSAL STUDS (SLABS & JOISTS)

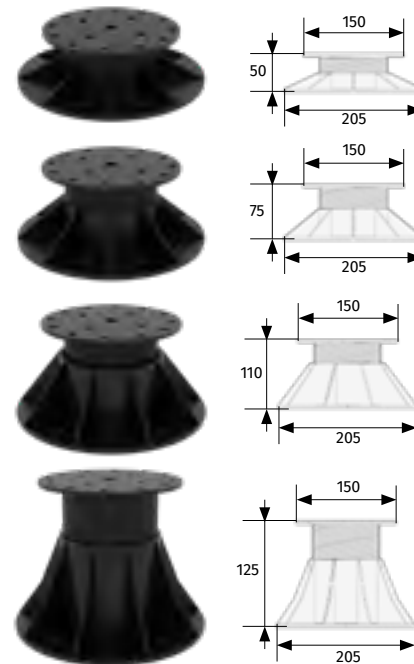

Features

- 35 to 480 mm adjustable base for fast and efficient installation
- Precise height adjustment by means of the reversing system
- Strong supports up to 1.2 ton in high position. Ideal for terraces in commercial and Heavy Duty use
- Retains its strength and stability even under intense and frequent stress.
- Allows air circulation under the deck, as well as the passage of cables and ducts.
- Compatible for tiles, joists, and STRUCTURAL concept

Designation	Code FR	Code NL	EAN Code	Qty/package	Qty/pallet	Weight (kg)
H 35 - 50 mm	1279	2563	3700421812790	90	1440	0,31
H 50 - 75 mm	1280	2564	3700421812806	63	1008	0,36
H 75 - 110 mm	1281	2565	3700421812813	45	720	0,40
H 110 - 180 mm	1282	2566	3700421812820	36	576	0,55

Designation	Code FR	Code NL	EAN Code	Qty/package	Qty/pallet	Weight (kg)
Extension stud H 65 - 110 mm	1283	2567	3700421812837	125	2000	0,26
NIVO HD Adapter - Beam 40x60 mm	1284	2568	3700421812844	270		0,02
Crosspiece 3 mm	1285	2569	3700421812851	750		0,01

Features

- Strong, rot-proof, ultra-light and quick to install thanks to the Cobra Tee-Al clip
- Superior durability to conventional wood structures in all weather conditions
- Extends the life of the structure and the guarantee of the decking
- Excellent mechanical resistance, no deformation, perfect flatness



N°	Designation	Code FR	Code NL	EAN Code	Qty/package	Qty/pallet	Weight (kg)
1	Aluminum joists 40x60x3000 mm	0676		3700421806768	3	180	4,28
2.1	NIVO adapter joist 40x60 mm	0677	2194	3700421806775	20	1920	0,06
2.2	Adapter NIVO HD joist 40x60 mm	1284	2568	3700421812844	270	0	0,02
3	Sleeve connector (10 pcs)	0687	2187	3700421806874	20	400	0,40
4	Joist bridge 30 to 50 mm (4 pcs)	0965		3700421809653	20	480	0,50
5	Black bracket 35x35x1,5 mm (20 pcs)	0686	2193	3700421806867	20	400	0,26
6	Cobra Tee AL (90 pcs)	0678	2195	3700421806782	20	600	0,95
7	Start/end clip (10 pcs)	0689	2196	3700421806898	20	400	0,23

	Type 1 Residential application	Type 2 Commercial application
Distance between 2 supports maximum	75 cm	37,5 cm

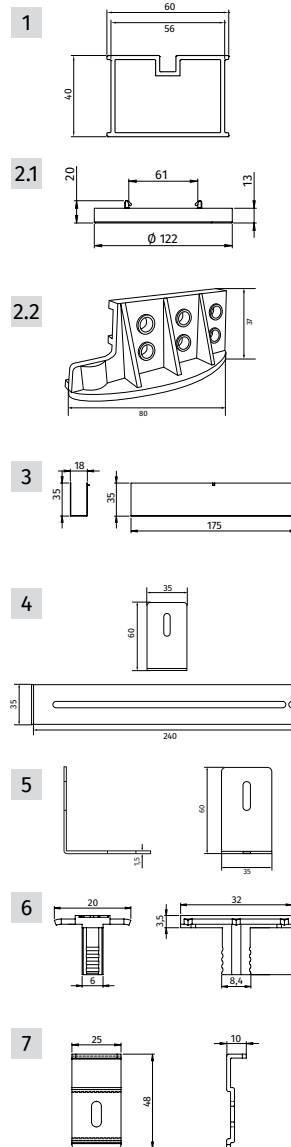

Installing STRUCTUR'AL joists on NIVO® pedestals - 2.1



Installing STRUCTUR'AL joists on NIVO H pedestals - 2.2



Designation	Code FR	Code NL	EAN Code	Qty/package	Qty/pallet	Weight (kg)
Joists 30x50x2400 mm	0871		3700421808717	4	148	1,98
EPDM tape 5x10 mm - 20 m	0939	2389	3700421809394	20	200	0,16
Sleeve connector (4 pcs)	1024	2391	3700421810246	10	400	1,50
Square (20 pcs) + Screws (40 pcs)	1032	2390	3700421810321	20	400	0,26

Designation	Code FR	Code NL	EAN Code	Qty/package	Qty/pallet	Weight (kg)
Alu joist 24x40 mm x4,0 m - Thickness 2 mm		1725	8718104305540		240	3,50
EPDM tape 5x10 mm - 20 m	0939	2389	3700421809394	20	200	0,16

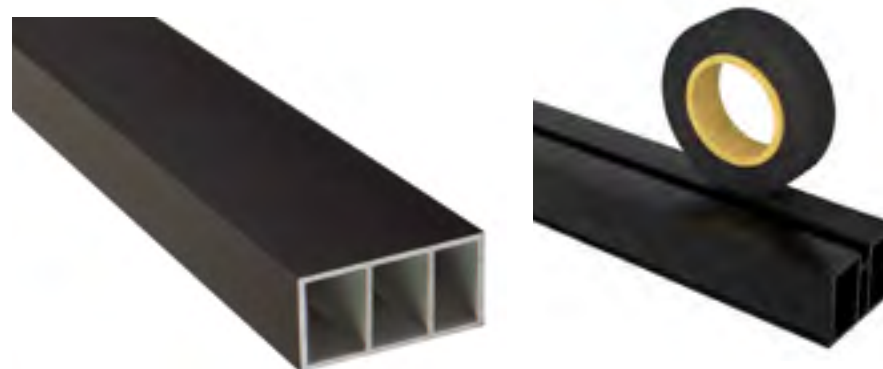

STRUCTURE

Ground screws



Features

- Hot galvanized steel according to NF EN ISO 1461:2009 standard
- Easy to install: No holes to dig, no concrete to pour, no earth to evacuate
- Low cost : Less expensive than a concrete structure
- Strong : up to 450 kg of load compression
- Removable L-shaped support included, compatible with most joists in the market
- Flat bracket (sold separately) for fixing vertical posts
- Easy to remove and reusable

Designation	Code FR	Code NL	EAN Code	Qty/package	Qty/pallet	Weight (kg)
800 x Ø 60 cm	0614	2383	3700421806140	1	56	5,00
1200 x Ø 60 cm	1220		3700421812202	1	56	7,50
Flat support 90x90 mm	1221		3700421812219	20	300	0,70

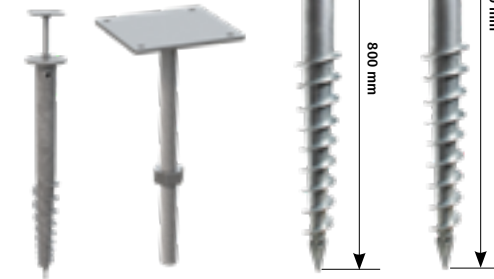
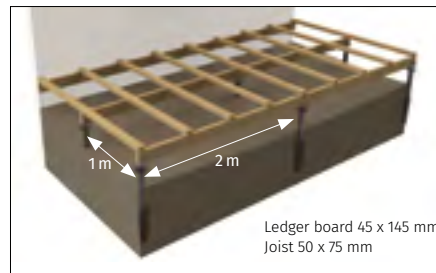
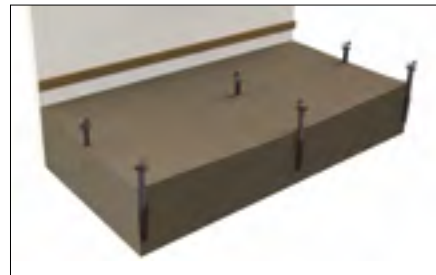

STRUCTURE

Ground screws



Manual or electric screwing time: < 5 minutes.



MANUAL VISSAGE

Features

- Allows the ground screw to be anchored manually without the use of other materials
- Manual screwing bar with height adjustment as you screw in.
- Wingspan of 160 cm: an important lever arm for easy tightening

Code FR	Code NL	EAN Code	Qty/package	Qty/pallet	Weight (kg)
0615	2384	3700421806157	1	49	7,90

Manual tool kit



MECHANICAL SCREWING

Features

- Adapter for mechanical screwdriving with impact bolting machine
- Compatible with the Makita TW1000 Impact Bolting Machine, BOSCH Gds 30 Professional, Hitachi Wr25SE 900W 1000 Nm



Code FR	Code NL	EAN Code	Qty/package	Qty/pallet	Weight (kg)
0616	2385	3700421806164	10	200	1,35



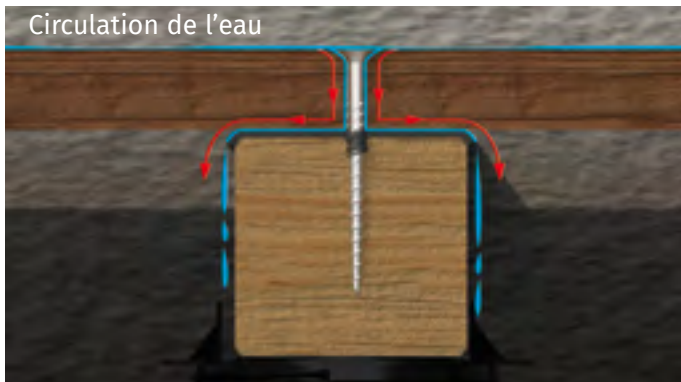

Features

- Increases the life time of wooden joists
- Complies with the requirements of decking standards
- Waterproof - Absorbs sound resonance
- Matte black color to avoid light reflections between boards
- Resists tearing, deformation, and temperature variations
- Easy and convenient to use

Code FR	Code NL	EAN Code	Qty/package	Qty/pallet	Weight (kg)
0145	2306	3760178990196	8	240	1,55

Dimensions & Properties

Property	Value
Nominal thickness	1.5 mm
Width	75 mm
Length	10 m
Upper side	Self-adhesive elastomeric bitumen
Bottom side	HDPE Film
Tensile strength	150 N
Resistance to nail tearing	25 N
Operating temperature	-20°C to +70°C
Storage conditions	+15°C
Waterproofing	0.3 mpa, 120 min
Stickiness	1.5





GEOTEXTILE FELT 100 GR/M²

Features

- Prevents weed regrowth
- Can be laid directly on the ground, soil, grass...
- Water permeable

Code FR	Code NL	EAN Code	Dimensions	Qty/package	Qty/pallet	Weight (kg)
0607	2387	3760178990219	2x10=20 m ²	15	60	2,00

Properties

Weight	Thickness	Resistance to tearing*	Widthwise traction**	Elongation at maximum tensile load
100 g/m ²	0,55 mm	0,413 kN	13,6 kN/m	132%

*ISO 12236 : 2006

**ISO 10319 : 2015

MULCHING FABRIC 100 GR/M²

Features

- Prevents weed regrowth
- Can be laid directly on the ground, soil, grass...
- Water permeable

Code FR	Code NL	EAN Code	Dimensions	Qty/package	Qty/pallet	Weight (kg)
	1032	8718104300576	2x5=10 m ²	10	150	1,00

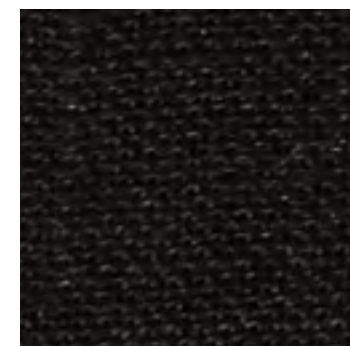

FLATPAD

Features

- Quick and accurate upgrade
- Allows to correct thicknesses from 2 to 5 mm
- Rot-proof, strong and UV-resistant

Code FR	Code NL	EAN Code	Qty/package	Qty/pallet	Weight (kg)
0135	1779	3760178990189	10	200	0,80

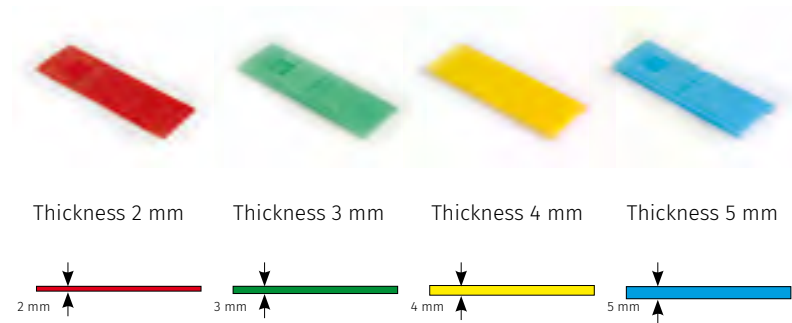

WEDGEPAD

Features

- Quick and accurate upgrade
- Allows to correct thicknesses from 10 to 30 mm
- Rot-proof, strong and UV-resistant
- Can be screwed or glued

Code FR	Code NL	EAN Code	Qty/package	Qty/pallet	Weight (kg)
0610	1780	3700421806102	6	144	1,00

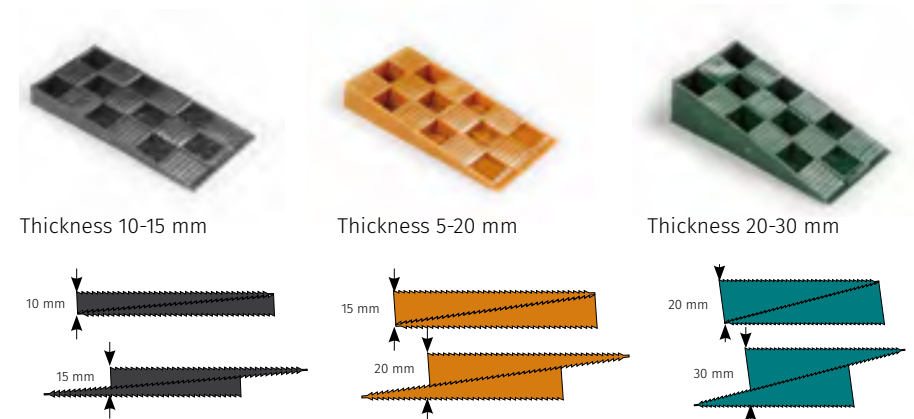

FORKPAD

Features

- Snap-on tab
- Variable opening from 8 to 12 mm
- Can be fixed into the nylon anchor

Code FR	Code NL	EAN Code	Qty/package	Qty/pallet	Weight (kg)
0679	2388	3700421806799	12	144	0,61



RUBBERPAD

Features

- Increases the lifetime of the under-structure
- Allows the circulation of rainwater under the joists
- Protects the joists against soil moisture
- RotproofShore hardness: 55A
- Density: 730 kg/m³



Designation	Code FR	Code NL	EAN Code	Qty/package	Qty/pallet	Weight (kg)
RubberPad 8x90x90 mm (24 pcs)	0210	1058	3760178990936	10	200	1,20
RubberPad 8x60x90 mm (48 pcs)	0608	1777	3700421806089	12	384	1,45
RubberPad 3x60x90 mm (60 pcs)	0609	1776	3700421806096	24	768	0,60

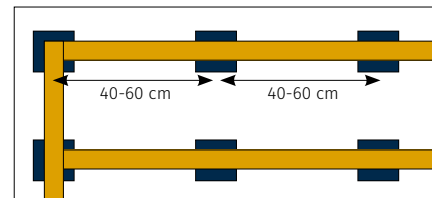

“Boat deck” joint

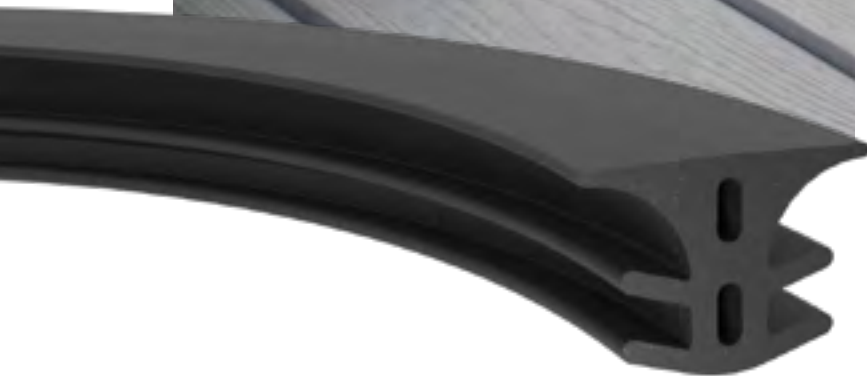

Description

Elastomeric joint, allows a watertight seal between deck boards spaced 4 to 6 mm apart.

Composition

Thermoplastic elastomer rubber of density 1.18 TPS- type S.E.B.S. This high quality material has an excellent resistance to atmospheric agents, aging, U.V. It is 100% recyclable. Used in the automotive industry. Resists temperature variations between -50°C and +90°C.

Installation

Unroll the joint and press it by a simple thumb pressure on the elastomer cord. Thin edges hold the joint in the gap between the deck boards.

Use

Cobra SEAL is particularly suitable for covered terraces, café terraces, restaurants, bathrooms, covered swimming pool decks, covered balconies, etc. Prevents the fall of debris between the boards. Boat deck appearance. Be careful to maintain good ventilation of the terrace underneath.



Code FR	Code NL	EAN Code	Qty/package	Qty/pallet	Weight (kg)
1124	2307	3700421811243	5	60	2,90

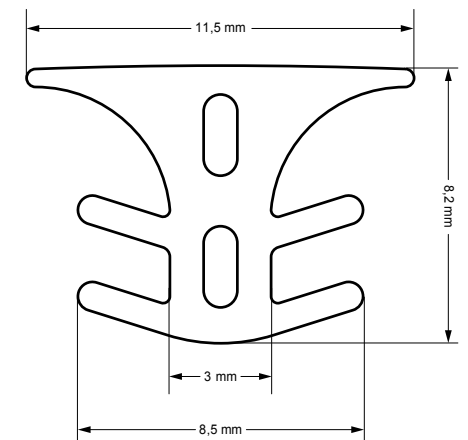
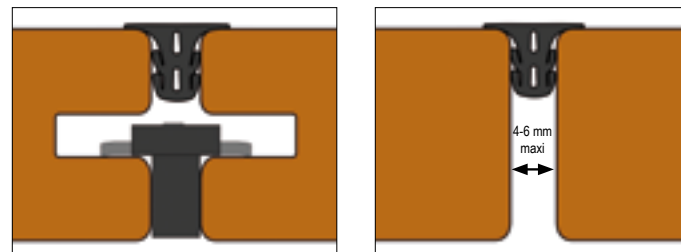



www.cobrafastener.com