

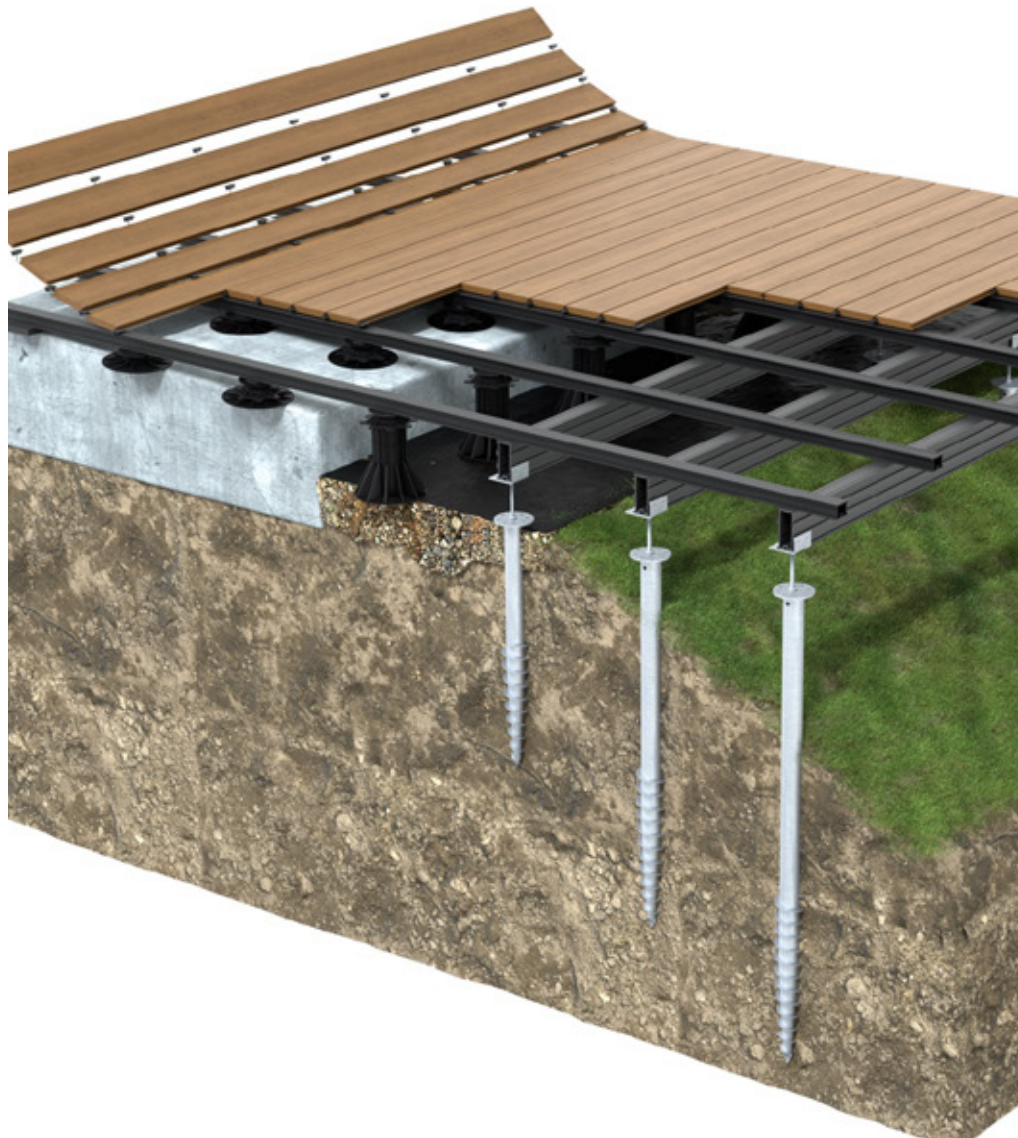

**STRUCTURAL® ALUMINUM TERRACE STRUCTURE**  
A HIGH-PERFORMANCE, VERSATILE AND SUSTAINABLE SOLUTION



## A DURABLE & VERSATILE SYSTEM

The STRUCTURAL® system gives you a rot-proof **structure that resists moisture and mould perfectly**, for an incomparable lifespan.

The aluminum joists are suitable for all types of environments and conditions. Unlike wooden structures, aluminum **joists are not subject to deformation or deterioration**.

### A terrace for life!

The lightweight and high-performance STRUCTURAL joists are load-bearing elements perfectly **adapted for elevated structures** on adjustable blocks or ground screws.

STRUCTURAL can be **laid on any type of soil or floor**, whether hard, stabilized, loose or waterproof.

Its **modularity** means it can be used to meet a wide range of constraints or needs, from installing **composite or wooden deck boards** to laying **porcelain stoneware slabs**

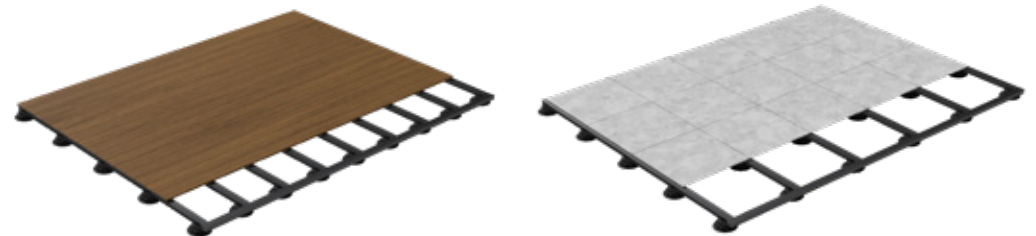

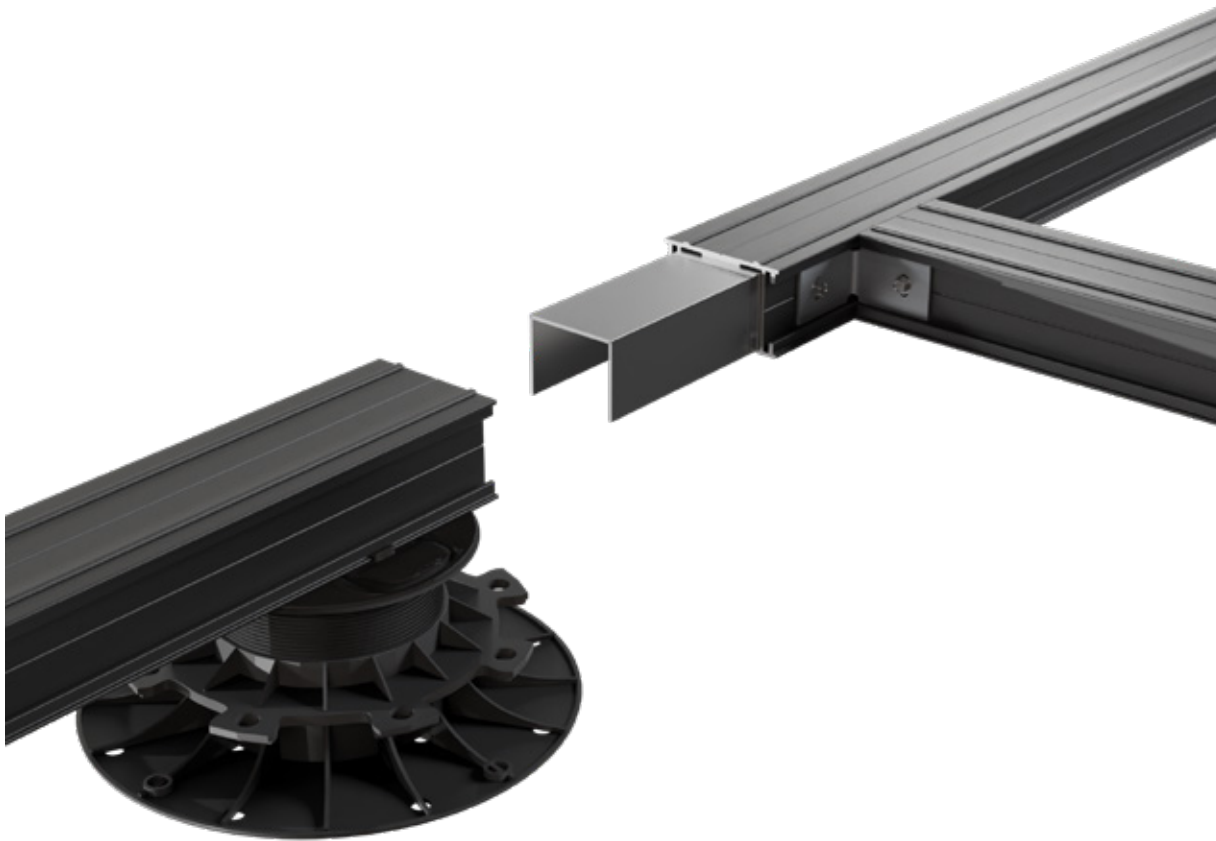

## ALL YOU NEED TO KNOW

- Quick and easy assembly
- Modular and dismantable
- Excellent mechanical resistance
- Precision and consistency - Perfectly flat
- Easy to install on elevations and on all types of floor
- Versatile for laying decking or paving slabs
- Rot-proof - Weather and parasites resistant
- Durable - Performance that never fades





# The heart of the **STRUCTURAL**<sup>®</sup>

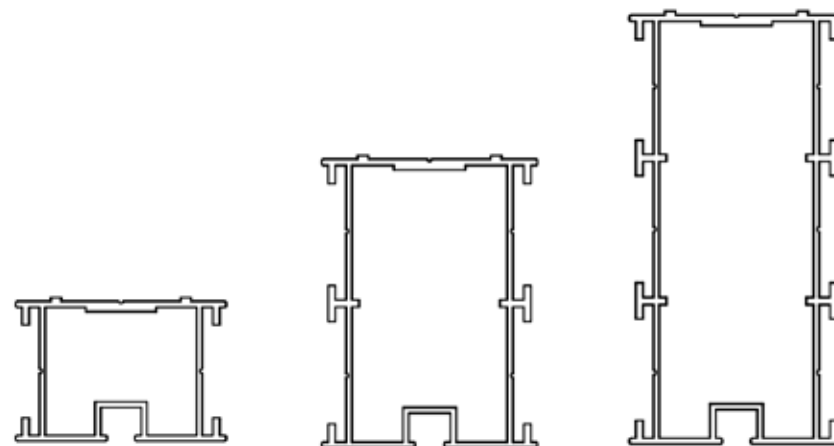

## ALUMINIUM JOISTS

## DESIGN & CHARACTERISTICS



40 x 60 x 2300 mm h x l x L	40 x 60 x 4000 mm h x l x L	80 x 60 x 4000 mm h x l x L	120 x 60 x 4000 mm h x l x L
<b>FD1900 – NL2853</b>	<b>FD1892 – NL2846</b>	<b>FD1893 – NL2847</b>	<b>FD1894 – NL2848</b>
2,6 kg	4,6 kg	6,9 kg	9,8 kg
1 M 	1 M 	2 M 	3 M 

<b>Material</b>	Aluminium alloy EN AW 6063 (T5)		
<b>Finish</b>	Black lacquer RAL 9005 Matt		
<b>Usage</b>	Top side Side	Bottom	Laying decking Laying paving

# STRUCTURAL® Brackets



## JOINTING SQUARE FOR DECK BOARDS (FD1895 – NL2849)

- Allows optimal jointing of deck boards without double joisting
- 2-metre rail can be cut to size for optimum use depending on the type of installation and the width of the decking to be joined
- Hook for easy installation and screwing comfort
- Compatible with installation using side clips or wood/aluminum screw

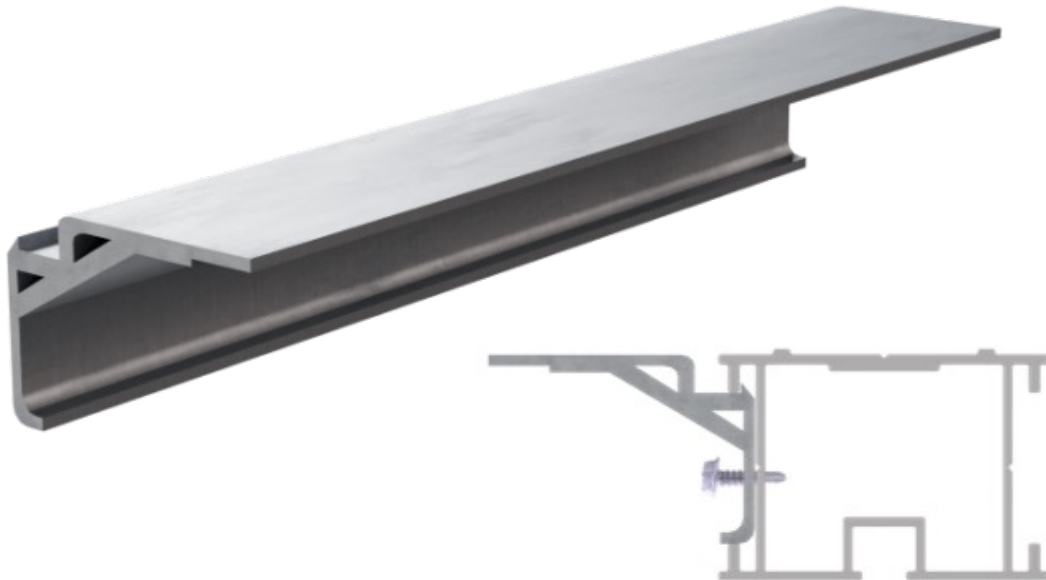

## CUT TO SIZE



## CLIPPED DECKING

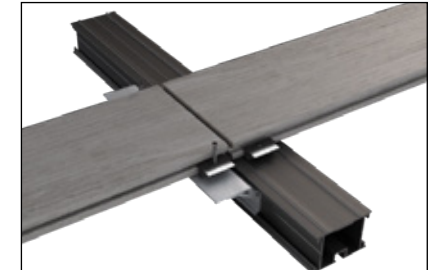
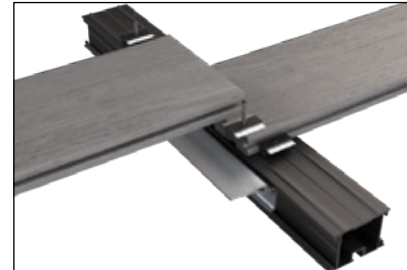

## SCREWED DECKING



# STRUCTURAL<sup>®</sup> Brackets



## FOLDING CORNER BRACKET (FD1898 – NL2854)

- Corner joint between joists
- Pre-drilled and designed for easy screwing
- Foldable to adapt to the geometry of the structure

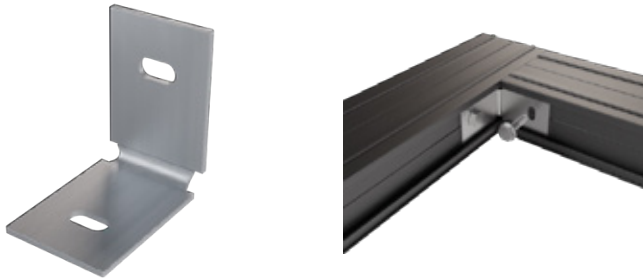

## 90° FLAT SQUARE (FD1899 – NL2861)

- Allows vertical elements to be installed
- Ideal for creating steps
- Pre-drilled for easy screwing



## FIXING SQUARE (FD1897 – NL2862)

- Fixed into the ground or for double joisting
- Pre-drilled and designed for easy installation and wedging
- Allows ballast to be laid with structures not fixed to a watertight floor

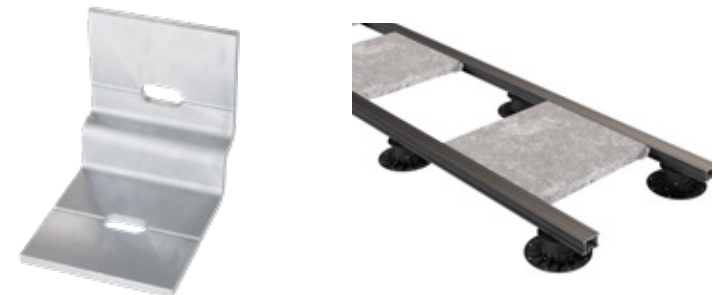
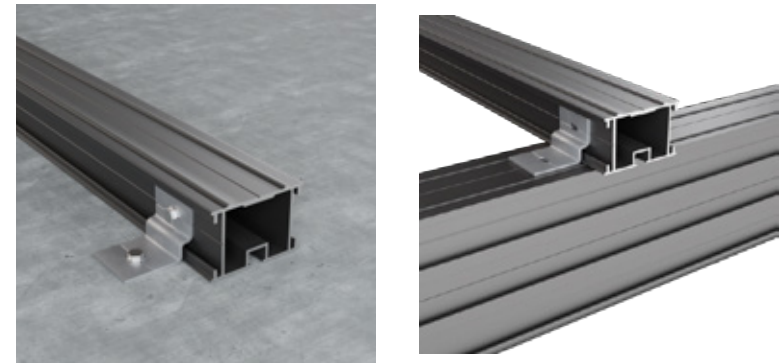

# STRUCTURAL<sup>®</sup> accessories



## BUTTING SLEEVE FOR JOISTS (FD1896 – NL2852)

- Allows joists connection
- Compatible with all 3 joist sections
- 18 cm long with practical marking indicating the middle

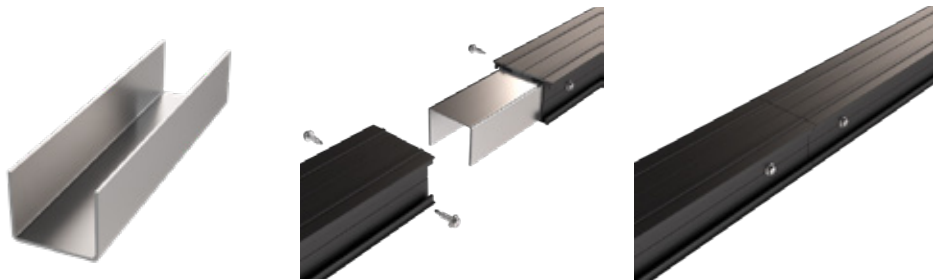

## EPDM TAPE (FD0939 – NL2389)

- Self-adhesive strips
- 5 mm thick - 10 mm wide
- 2 x 10 linear metres

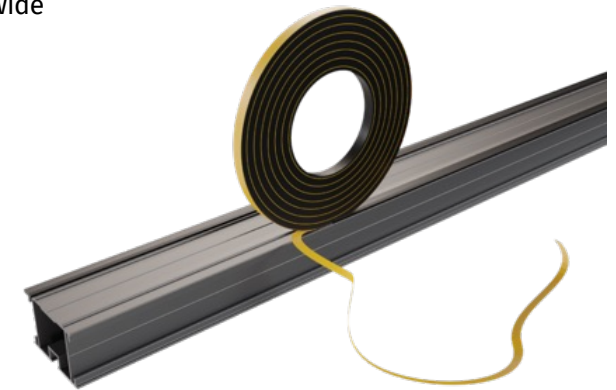

## SELF-DRILLING STAINLESS STEEL SCREW (FD1903 – NL2863)

- AISI 410 stainless steel screws, 16 mm long with hexagonal head
- Drilling capacity in aluminium: 5 mm
- Box of 100 pcs - Single screw for all brackets and accessories



## FINISHING PROFILE (FD1938 – NL2867)

- L 35 x h 60 mm - Length 2 m
- Matt black lacquer RAL 9005

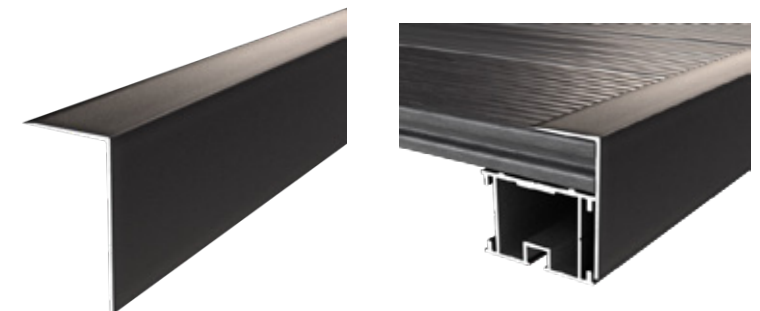

# STRUCTURAL ACCESSORIES ON JOISTS 40X60

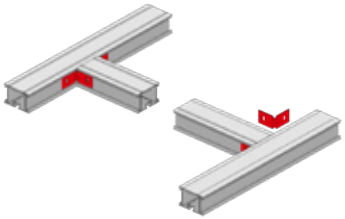

FD1898-NL2854

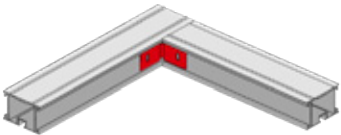

FD1898-NL2854

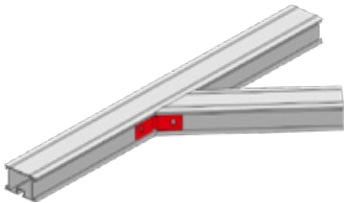

FD1898-NL2854

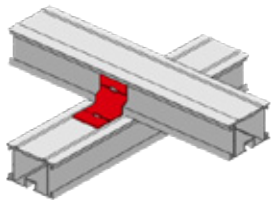

FD1897-NL2862

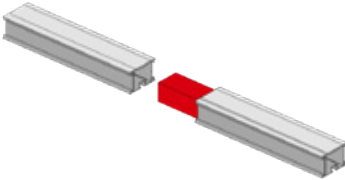

FD1896-NL2852

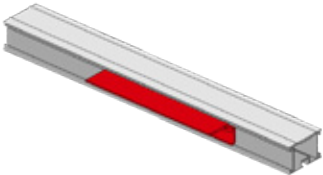

FD1895-NL2849



FD1899-NL2861





# STRUCTURAL ACCESSORIES ON JOISTS 80X60

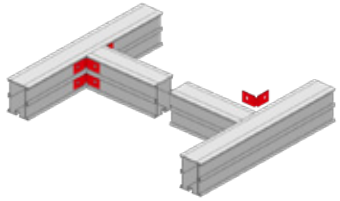

FD1898-NL2854

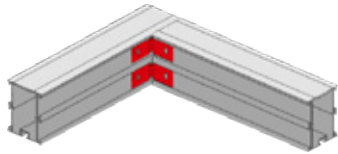

FD1898-NL2854

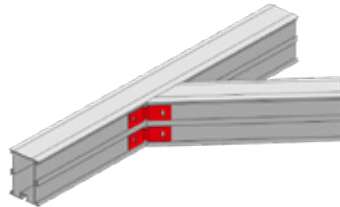

FD1898-NL2854

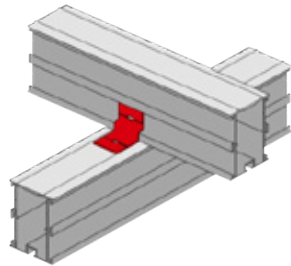

FD1897-NL2862

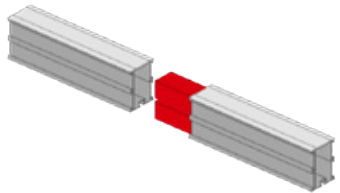

FD1896-NL2852

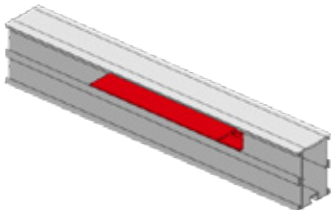

FD1895-NL2849



FD1899-NL2861

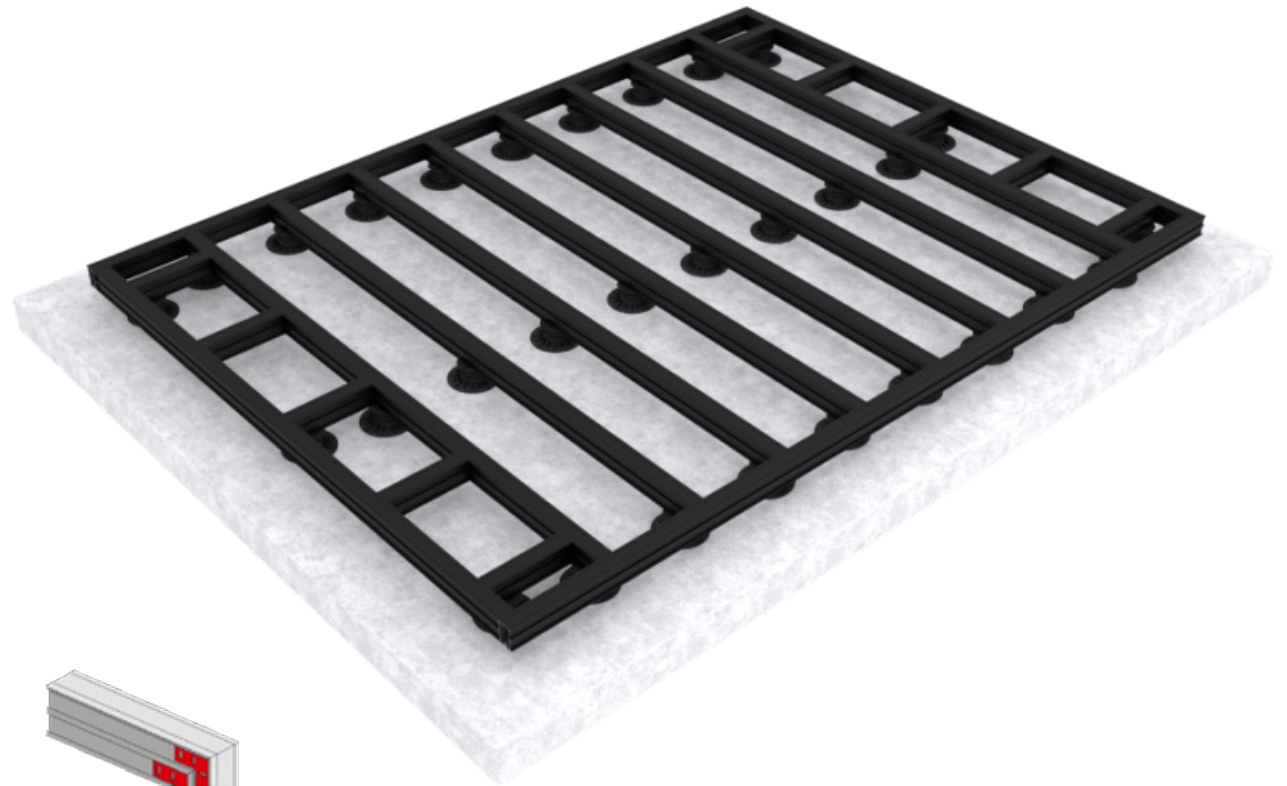

# STRUCTURAL ACCESSORIES ON JOISTS 120X60

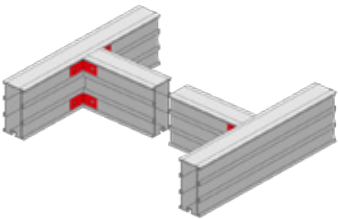

FD1898-NL2854

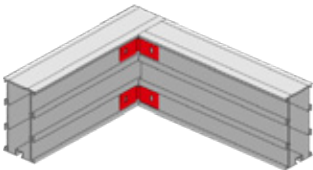

FD1898-NL2854

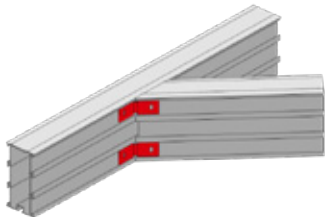

FD1898-NL2854

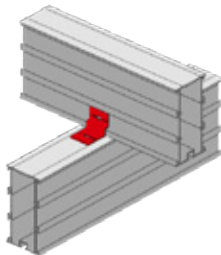

FD1897-NL2862

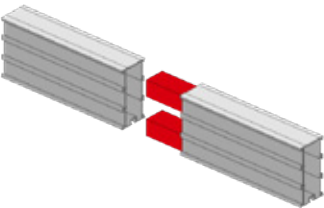

FD1896-NL2852

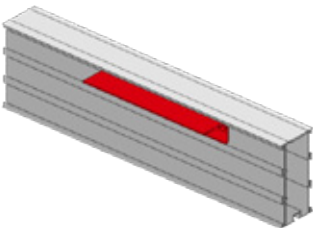

FD1895-NL2849

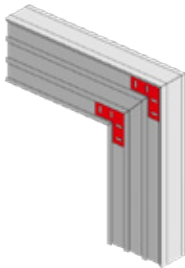

FD1899-NL2861

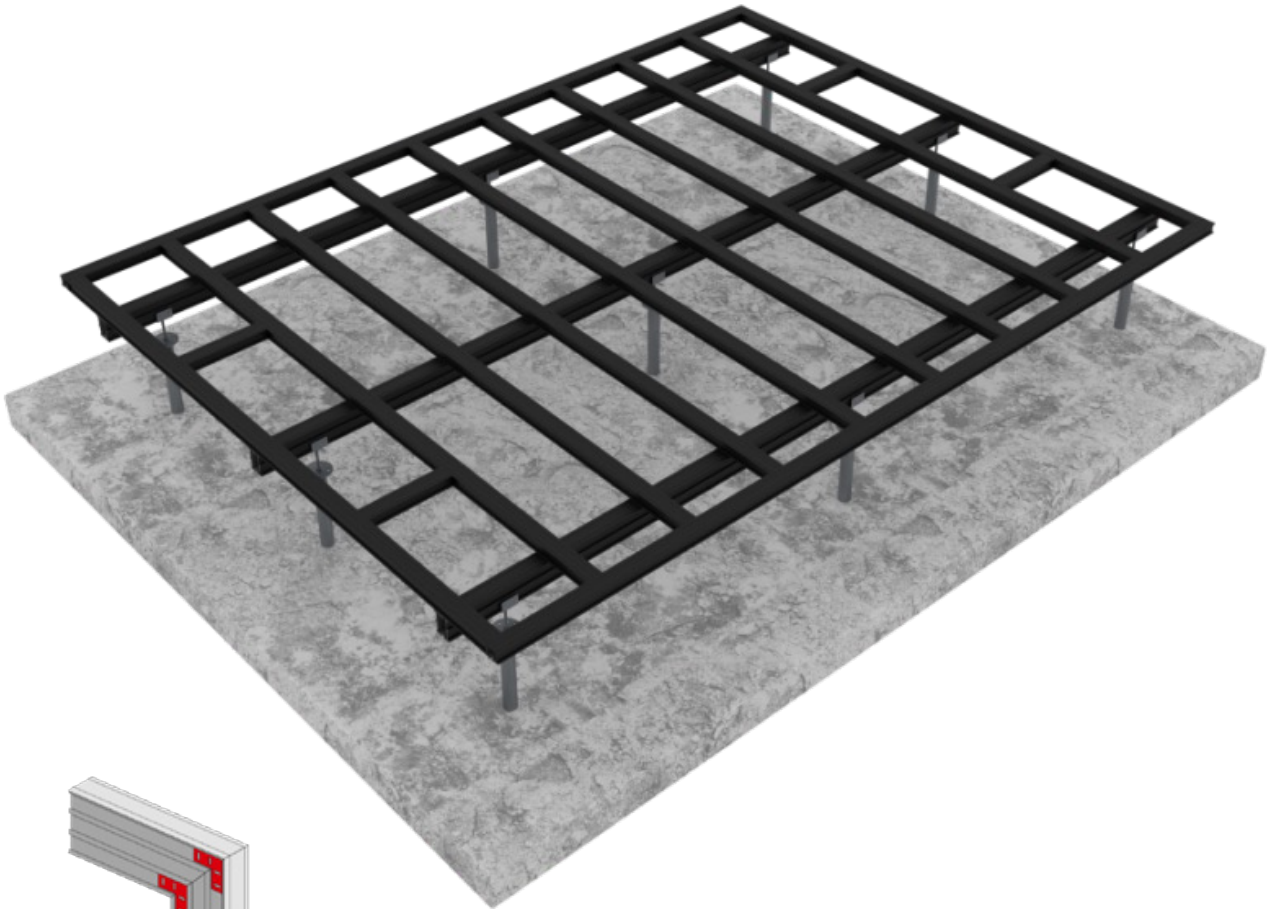

# FASTENERS FOR DECKING ON STRUCTURAL®



## COBRA HYBRID CLIPS

- Hybrid 8-25 for laying hardwood (FD0984-NL2662)
- Hybrid 7-22 for laying bamboo or thermo wood (FD1334-NL2661)
- Hybrid 8-18 for laying composite (FD0993-NL2174)



## AIR SPACER

(FD1040 – NL2619)

- Ensures ventilation between boards and joists
- Compatible with Cobra Hybrid clips and standard screws
- Recycled polyamide: UV, heat and frost resistant



## PROFILE DRAWN FOR EASY INSTALLATION

- 2 guides to position the Hybrid clips and Air spacer perfectly
- 1 central drilling groove
- 3 mm d'aluminium wall for a firm grip on screws
- 2 side spaces to suit EPDM strips sticking



## STAINLESS STEEL SCREW FOR JOISTS

- Selfdrilling point for wood and aluminium
- Deep TORX print
- Sizes to suit different decking thicknesses



# DECKING INSTALLATION WITH CLIPS OR SCREWS + **AIR SPACER ON STRUCTURAL**®



## CLIPPED DECKING



## SCREWED DECKING

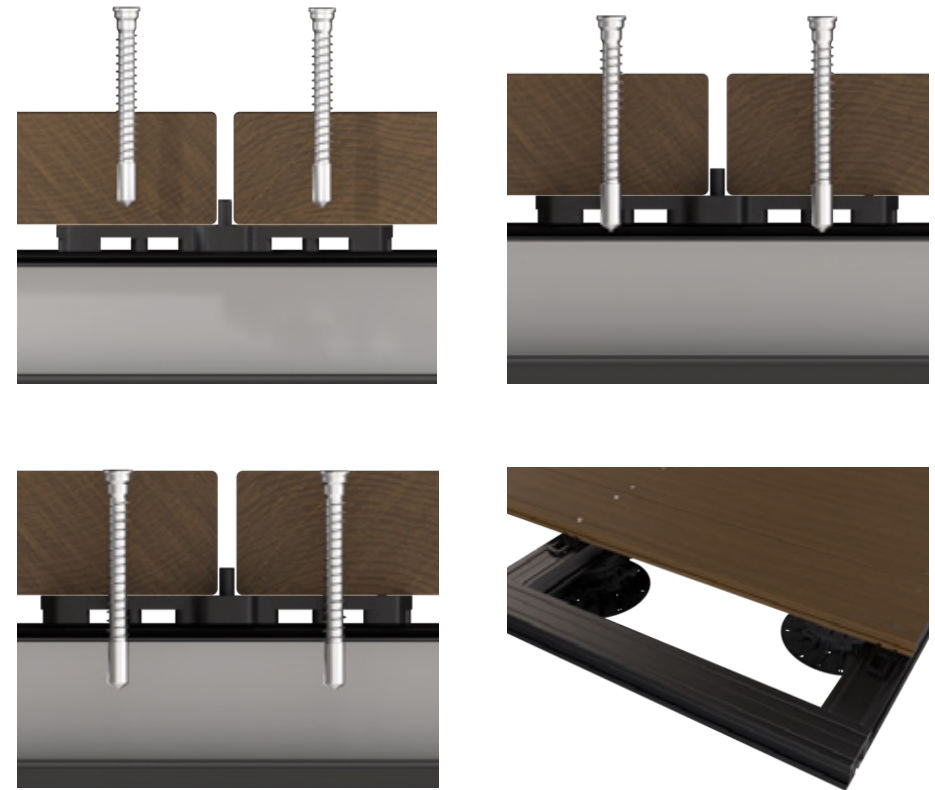

# FASTENERS FOR DECKING ON STRUCTURAL®



## AL60 OVERHANG FOR NIVO STUDS (FD1357 - NL)

- Clipping disc for 60 mm joist to be placed on the NIVO tile block



## NIVO PLUS STUD HEAD (FD1810 - NL)

- NIVO + clipping disc for 60 mm aluminum joist



## EASY, FAST AND APPROPRIATE

- Simple clip-on installation and removal of joists.
- STRUCTURAL offers a span of 1 to 3 metres between supports, depending on the cross-section of the joist.
- Thanks to STRUCTURAL, the perimeter pedestals can be hidden by being positioned on inside parts of an adapted frame. Ideal for the deck finishing



# SCREW INSTALLATION FOUNDATION

## AN ALTERNATIVE THAT METTS LEVEL & GROUND CONSTRAINTS

- STRUCTURAL joist allow double joisting building for installation on foundations screws
- Fixed on the adjustable head of the foundation screw
- Connection between joist and beams with the STRUCTURAL fixing bracket
- The system offers exceptional spans and overhangs

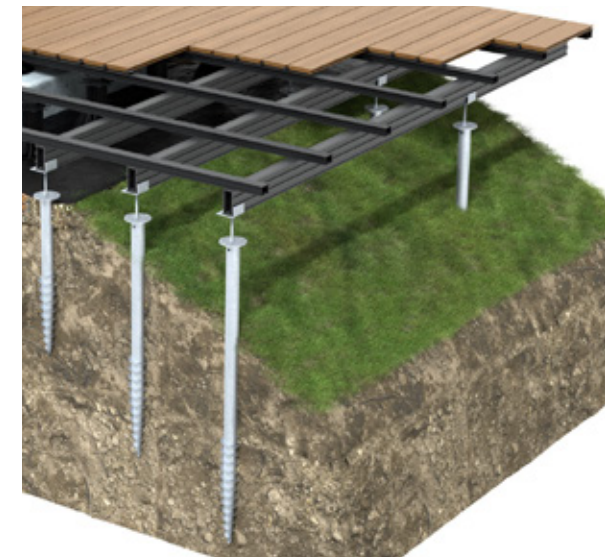

Maximum spans	Beams sections			Overhang
	60x40	60x80	60x120	
Joist 60x40	0,85 m	1,30 m	1,80 m	15 à 18,5 cm
Joist 60x80	X	1,15 m	1,45 m	30 à 41 cm
Joist 60x120	X	X	1,30 m	50 à 65 cm

# LAYING CERAMIC PAVING ON STRUCTURAL<sup>®</sup> AN IDEAL, EASY-TO-USE STRUCTURE



- Laying the paving on a joist frame ensures optimum adjustment and levelling.
- The divisible crosspieces fit onto the joist and slide for easy, precise laying of the paving.
- EPM<sup>®</sup> bands are easy to stick on and provide noise comfort and cushioning
- This modular load-bearing structure allows for multiple geometries and facilitates the creation of the finishing elements

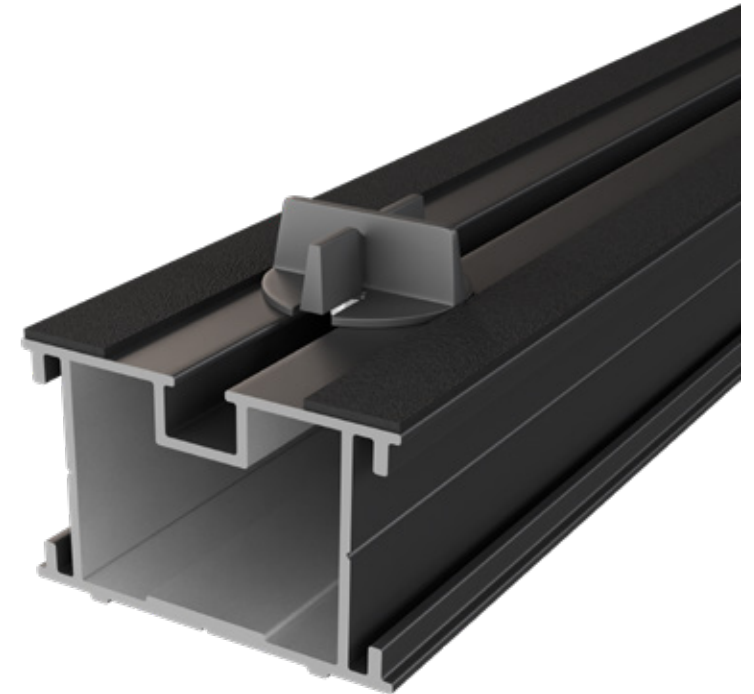

# Accessories **STRUCTURAL®** paving



## PAVING BRACE (FD0866 – NL2416)

- For laying and levelling paving slabs
- Slides easily into the groove of the joist
- Strippable to adapt to installation conditions (wall, rectangular formats, etc.)

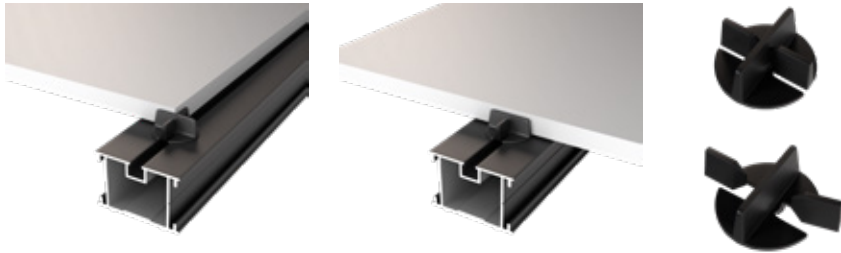

## HOOKS FOR SKIRTING BOARDS (FD0864 – NL2418)

- Top and bottom supports for ceramic skirting boards
- Easily fixed to the joist structure
- Suitable for 20 mm tiles



## SELF-ADHESIVE EPDM STRIP (FD0939 – NL2389)

- 5 mm thick - 10 mm wide
- 2 x 10 linear metres
- Provide cushioning and sound comfort

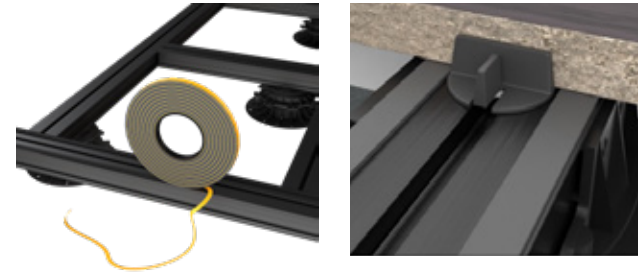

## ALUMINIUM FINISHING PROFILE (FD0867 – NL)

- Combined with the skirting hooks on top of 20 mm thick tiles
- Length 1,14 m, thickness 2 mm
- Perfect finish





